

Product Overview

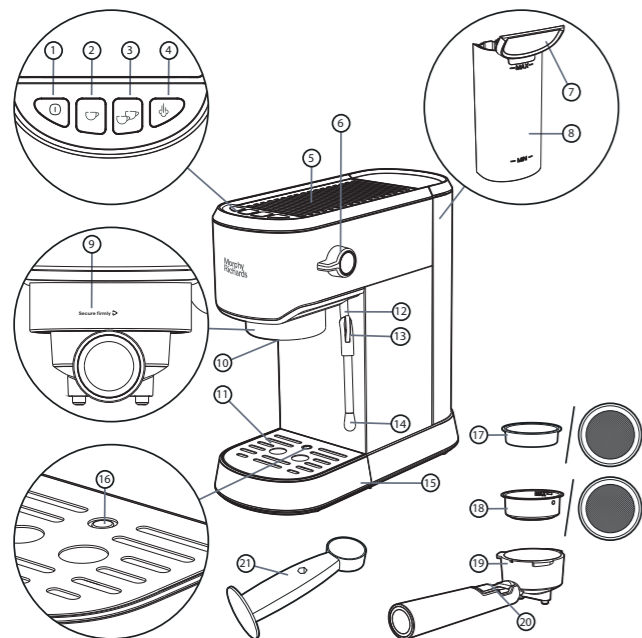

- | | | |
|------------------------|-------------------------------|---|
| 1 On/Standby Button | 9 Filter Holder Lock Position | 16 Drip Tray Full Indicator |
| 2 Two Cup Button | 10 Brewing Head | 17 Smaller One Cup Filter (for single shot use) |
| 3 One Cup Button | 11 Removable Drip Tray Grid | 18 Larger Two Cup Filter (for double shot use) |
| 4 Steam Button | 12 Steam Wand | 19 Filter Holder |
| 5 Espresso Cups Holder | 13 Steam Wand Grip Tab | 20 Filter Holder Clip |
| 6 Steam Control Dial | 14 Steam Wand Nozzle | 21 Tamp Spoon |
| 7 Water Tank Lid | 15 Removable Drip Tray | |
| 8 Water Tank | | |

Before First Use

IMPORTANT: It is important that prior to using the coffee maker for the first time that water is flushed through the system and it is primed for making coffee.

NOTE: You may hear a pumping sound when water is passing through the system for the first time. This is normal and is caused by the air escaping from the system. The noise will cease after around 20 seconds.

Priming the Coffee Machine

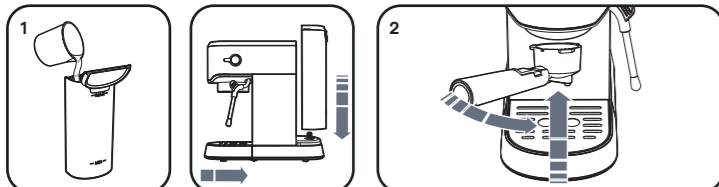

Ensure the Water Tank (8) is filled up to the MAX line. Assemble the Espresso Coffee Machine as above, ensuring the Removable Drip Tray (15) is in place.

Without placing any Filters (17/18) into the Filter Holder (19), place the Filter Holder into the Brewing Head (10) and turn until at a right angle to the Main Unit to lock into position securely.

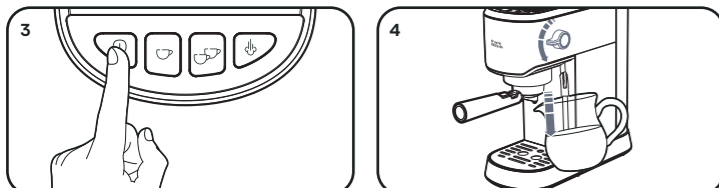

Ensure the Steam Control Dial (6) is in the off position and press the On/Standby Button (1). The One Cup and Two Cup Buttons (2/3) will pulse as the unit is heating up.

When the One Cup and Two Cup Buttons (2/3) illuminate solidly, place the Steam Wand (12) into a mug or jug and slowly turn the Steam Control Dial (6) until the water dispenses - keep the Dial open for at least 30 seconds and close the Dial. Take care performing this process as the hot water will pulse into the receptacle, and it may emit steam. Dispose of the water and repeat the process a further two times.

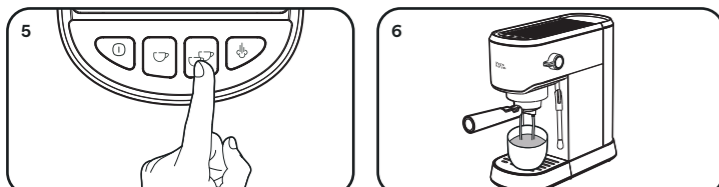

Following action no.4, wait for the One Cup and Two Cup Buttons (2/3) to illuminate solidly. Then place a receptacle, capable of holding 150ml, on the Drip Tray Grid (11) and press the Two Cup Button (3).

Water will pass through the system into the receptacle, which then must be emptied. Repeat a further 3 times - the coffee machine is now primed for making coffee.

Preheating (Optional)

For a hot Espresso, we recommend preheating the appliance before following the instructions on the next page. Preheating ensures the Filter Holder and cup are warm enough to enhance the coffee flavour.

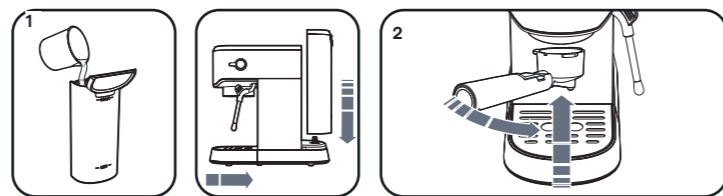

Fill the Water Tank (8) up to the MAX line. Assemble the Espresso Coffee Machine as above, ensuring the Removable Drip Tray (15) is in place.

Place the Coffee Filter (17/18) into the Filter Holder (19) without coffee in the Filter. Place the Filter Holder into the Brewing Head (10) and turn until at a right angle to the Main Unit to lock into position securely.

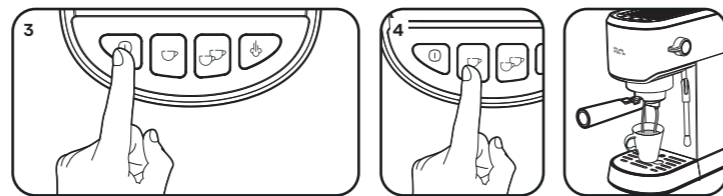

Plug the Espresso Coffee Machine in and press the On/Standby Button (1). The button will illuminate and remain on until the coffee machine is switched off again. The One Cup and Two Cup Buttons (2/3) will pulse.

When the One Cup and Two Cup Buttons (2/3) illuminate solidly, place your cup(s) on the Drip Tray Grid (11). Press either the One or Two Cup Button to dispense set amount, approximately 50ml for one cup and 100ml for two.

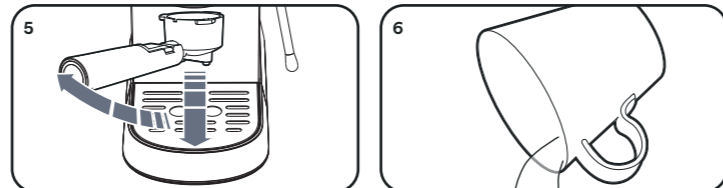

Remove the warmed Filter Holder (19), ready for use (see steps 2 and 3 under 'Using Your Coffee Maker').

Empty the water from your Espresso cup. Next, follow steps 2 onwards under 'Using Your Coffee Maker', using your preheated Espresso cup.

Re-filling the water tank

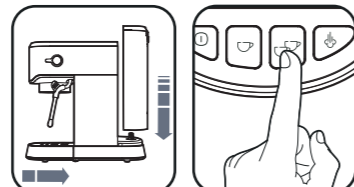

If the Water Tank (8) runs dry, after re-filling it may require two or more presses of the One Cup and/or Two Cup Buttons (2/3) for water to flow through the system to make an espresso.

Using Your Coffee Maker

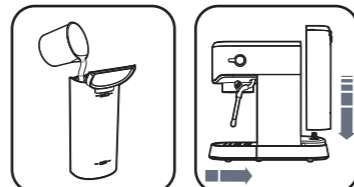

Your Espresso Coffee Machine uses espresso ground coffee and comes with two suitable Filters. The smaller one cup Filter (17) is for single shot use and the larger two cup Filter (18) is for double shot use.

Fill the Water Tank (8) up to the MAX line. Assemble the Espresso Coffee Machine as above.

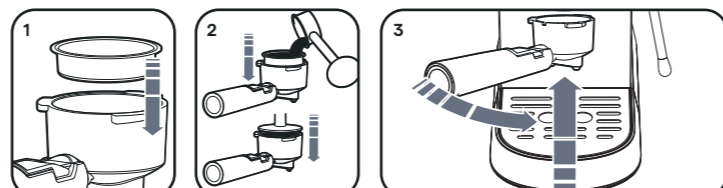

Place the Espresso Filter into the Filter Holder (19). Fill the Filter with fine espresso ground coffee to just below the top rim and compact it down with the Tamp Spoon (21).

Place the Filter Holder into the Brewing Head (10) and turn until at a right angle to the Main Unit to lock into position securely.

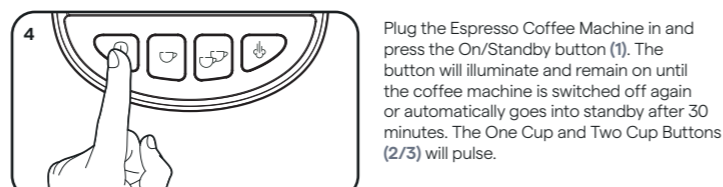

Plug the Espresso Coffee Machine in and press the On/Standby button (1). The button will illuminate and remain on until the coffee machine is switched off again or automatically goes into standby after 30 minutes. The One Cup and Two Cup Buttons (2/3) will pulse.

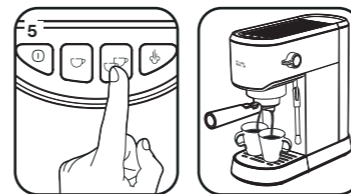

When the One Cup and Two Cup buttons (2/3) stop pulsing, place your cup(s) on the Drip Tray. Press either the One or Two Cup Button to dispense the set amount: approximately 40ml for one cup and 80ml for two. At the end of the dispensing time, the machine will beep once.

If the coffee machine is switched off by the user by pressing the On/Standby button (1); or if it automatically goes into standby mode (after 30 minutes), the machine can exit standby mode by a single press of the On/Standby button. This will start pre-heating the machine, and the One Cup and Two Cup Buttons (2/3) will pulse.

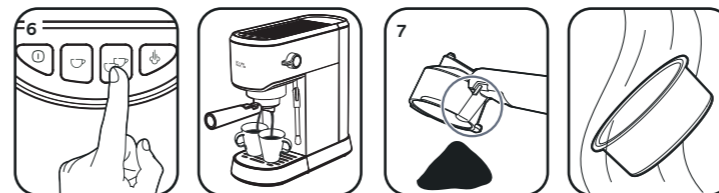

You may press and hold the One or Two cup Button to continue dispensing until the button is released. See 'Altering Dispense Amounts' for details.

Allow the grinds/pod to cool. Empty the coffee grinds, using the Filter Holder Clip (20) to keep the Filter in place. Remove the Filter and clean.

Using The Steam Wand

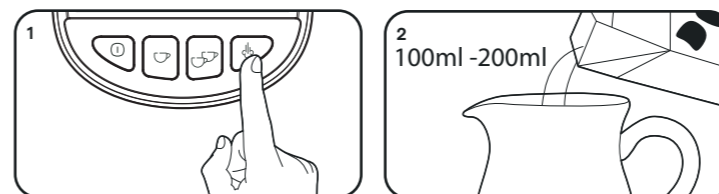

Press the Steam button - the button will pulse until the machine is up to Steam temperature. When the button stops pulsing, the Steam Wand is ready to be used.

Pour 100-200ml of chilled milk into a jug.

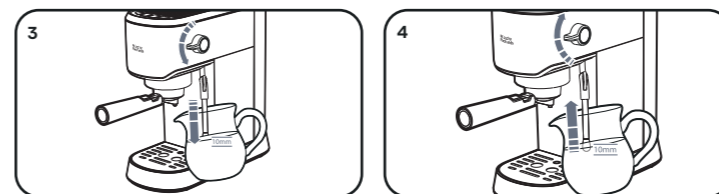

Place the Steam Wand (12) into the milk, slowly turn the Steam Control Dial (6) until steam is dispensed. Adjust to your liking.

When enough froth has been produced, turn the Steam Control Dial (6) to OFF.



Press the Steam Button (4) to exit the steam function. Serve the frothy milk. Press the On/Standby Button (1) to turn off the unit.

IMPORTANT: The Steam Wand must be cleaned after every use.

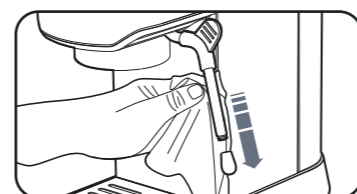

Allow the steam wand to cool before cleaning. To clean, remove the nozzle (14) and use a wet cloth to clean the Wand.

If another coffee is required after frothing milk, see 'Notes on Using the Steam Wand' for instructions on how to cool the machine.

Notes on Using the Steam Wand

If the unit is switched on with the Steam Control Dial (6) on, all buttons will flash. The Steam Control Dial must be turned to the off position.

If you want to make another coffee after using steam, ensure the Steam Control Dial (6) is in its off state and the One Cup and Two Cup Buttons (2/3) are pulsing, the unit is cooling down. The buttons will illuminate solidly when it's back down to temperature and ready to make coffee again. This can be accelerated by turning the Steam Control Dial to on - water will pump through and cool the system. Ensure there is a receptacle under the Steam Wand (12).

USAGE WARNING

ENSURE THE FILTER HOLDER (19) IS LOCKED INTO POSITION CORRECTLY AT A RIGHT ANGLE TO THE MAIN UNIT AND SECURELY LOCATED IN THE BREWING HEAD (10) BEFORE USE. WHEN FROTHING MILK, ENSURE THE STEAM CONTROL DIAL (6) IS OFF BEFORE REMOVING THE STEAM WAND (12) FROM THE MILK.



Please read and keep these instructions for future use

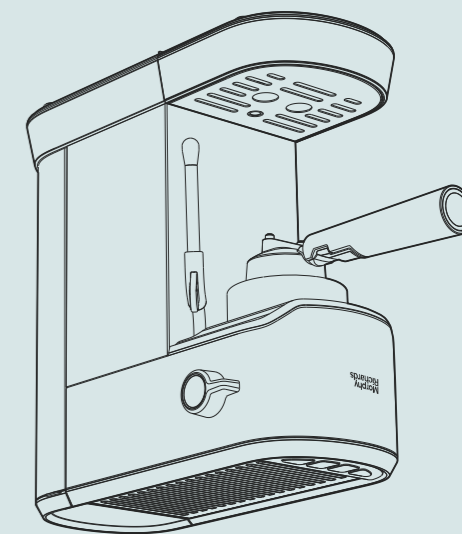

Espresso Machine Compact

Morphy Richards

Contact us

Help & Advice

If you have any difficulty with this product, please contact our customer care team who will be happy to help.

Email us: Hello@morphyrichards.com

Visit us: www.morphyrichards.com/contactus

Talk to us

If you have any questions or comments, or want some great tips to help you get the most out of your products, join us online:

Facebook: www.facebook.com/morphyrichardsuk

Twitter: [@loveyourmorphy](https://twitter.com/loveyourmorphy)

Address: **Stoney Lane
Prescot
Merseyside
L35 2XW
UK**

M
R.

UK
CA
CE

www.morphyrichards.com

CM172022MUK A3 Rev1

Altering Dispense Amounts

To change the volume dispensed for the One Cup program, begin by pressing and holding the One Cup button for 3 seconds, then releasing. Both the One Cup and Power button will stay lit. Press the One Cup button again and your coffee will start to pour. When you are happy with the amount of coffee that has been dispensed, press the One Cup button again to stop the coffee. The machine will beep, the buttons will all light up, and coffee will stop dispensing. This will now be stored in the machine for the next time you make a coffee. Repeat for the Two Cup if necessary.

NOTE: The range of volumes can be between 25ml and 60ml for the One Cup program, and between 70ml and 110ml for the Two Cup program."

Tip

After using the Steam Wand (12), the water in the boiling chamber will be too hot to brew coffee without burning the grinds. The water will be the correct temperature when the One Cup and Two Cup Buttons (2/3) illuminate solidly. The Two Cup and One Cup Buttons will not function until they are illuminated solidly.

Standby Mode

Your Espresso Coffee Machine will automatically switch off 30 minutes after brewing coffee. To reactivate the coffee maker, press the On/Standby Button (1) once to exit standby and start pre-heating for further use.

Emptying The Drip Tray

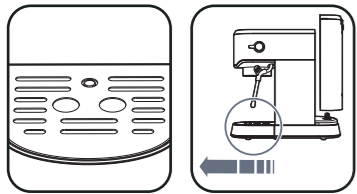

When the water in the Removable Drip Tray (14) is full, the Drip Tray Full Indicator (15) will be visible.

- 1 Remove the Drip Tray from the appliance and empty.
- 2 Clean the Drip Tray Grid (11) and Drip Tray with a damp cloth before replacing.

Adding Hot Water

The best way to add more hot water to your coffee is to use the Steam Wand: simply place your cup under the Steam Wand, and rotate the dial to the hot water position to dispense hot water, then turn to off when you have topped up your drink.

Cleaning Your Espresso Coffee Machine

- 1 Disconnect the appliance from the mains supply.
- 2 Make sure the appliance has completely cooled down.
- 3 Simply wipe the Steam Wand (12) and exterior with a clean, damp cloth.
Use a pin to clean the nozzle head and air holes in the Sleeve.
Do not use any abrasives or metal scourers as this will damage the finish on the unit.
- 4 The Filter Holder (19) and Water Tank (8) should be washed after each use by rinsing them under water. To assist in keeping the Filter Holder clean, we recommend you periodically run the machine with the Filter Holder in place, without coffee, using water only.
Should the holes in the Filters become blocked with coffee grinds, use a fine bristled brush to help clean.
When your coffee maker is not being used, we recommend that you do not leave the Filter Holder attached to the machine as this will reduce the life of the seal.
- 5 Remove the Drip Tray (11) and Drip Tray (14) from the appliance and remove any spilt coffee and water. Then, clean them with a damp cloth or a damp sponge.
- 6 You must clean the Steam Wand (12) immediately after each use. Place the Steam Wand in a jug or mug and use the steam setting to clear any remaining milk out of the Wand. After it has cooled down, remove the Steam Wand Sleeve, place under warm running water to remove excess milk. If the Steam Wand becomes blocked, use a small pin to clean more thoroughly.
WARNING: Steam from the Steam Wand is extremely hot and can scald.
IMPORTANT: Never wash your coffee machine accessories in a dishwasher.

Descaling

Your machine will need to be descaled regularly for better tasting coffee and maintenance. When the machine is turned on after 500 cycles, all the lights will flash 5 times – don't worry, you can still use the machine normally afterwards! To descale, follow the instructions below:

- 1 Disconnect the appliance from the mains supply.
- 2 Make sure the appliance has cooled down completely.
- 3 Remove the Water Tank (8) from the machine.
- 4 Fill the Water Tank with dissolved descaler solution (as per the manufacturer's instructions), up to the max level marked on the tank.
- 5 Re-fit the Water Tank to the machine.
- 6 Connect the appliance to the mains supply.
- 7 Press the On/Standby button (1) and wait for the One Cup and Two Cup buttons (2/3) to illuminate solidly.
- 8 Place a cup or bowl on the Drip Tray.
- 9 Press the Two Cup button (3) once, which will dispense hot water into the cup/bowl.
- 10 Repeat Step 9 three times, making sure to empty the cup/bowl when full.
- 11 Place the Steam Wand (12) into a cup or bowl, and slowly turn the Steam Control Dial (6) until hot water dispenses.
- 12 Keep dispensing into the cup/bowl until the Water Tank (8) is empty – make sure to stop and empty the cup/bowl when it is full.
- 13 Immediately refill the Water Tank with clean water, and repeat Steps 9-12.

After descaling has been completed, simultaneously press and hold the One Cup, Two Cup and Steam buttons for 3 seconds to cancel the descaling reminder (flashing lights).

Making Coffee

Your Espresso Compact machine allows you to create a variety of coffee drinks helping you to create the coffee shop experience in your own home. The diagrams on this page are a simple guide showing you the percentage of ingredients that make up each of the drink types. To see how to create the perfect espresso and frothy milk, scan the QR code on the sticker on your water tank and take a look at our online tips.



Troubleshooting

Problem	Reason	Solution
Water is dispensing from the Steam Wand (12)	Steam Control Dial (6) is open	Rotate the Steam Control Dial (6) so it is closed
The coffee temperature is too cold	Heater block is not hot enough before dispensing	Conduct a preheating process, see 'Preheating (Optional)' on page 6
The coffee grinds are wet after use	Coffee is not compact enough	Tamp the coffee before inserting
Espresso is weak	Wrong coffee type	Always use espresso coffee grinds
Milk is not frothing	Air and steam are not getting into the milk	Use a pin to clean the Steam Wand nozzle head (14)
Coffee is too strong or weak	Wrong volume of coffee	Use the correct coffee Filter: 1 person - Smaller One Cup Filter (17) 2 person - Larger Two Cup Filter (18)

All lights are flashing 5 times when turned on

The coffee maker needs descaling

Descalc following instructions. After descaling hold one cup, two cup and steam button for 3 seconds to cancel the reminder.

Registering your 2 year guarantee

Your standard one year guarantee is extended for an additional 12 months when you register the product within 28 days of purchase with Morphy Richards. If you do not register the product with Morphy Richards within 28 days, your product is guaranteed for 1 year. To validate your 2 year guarantee register with us online at www.morphyrichards.co.uk/support Or call our customer registration line
UK 0344 871 0242
IRE 1800 409 119

N.B. Each qualifying product needs to be registered with Morphy Richards individually. Please note that the 2 year guarantee is only available in the UK and Ireland. Please refer to the one year guarantee for more information.

Your 1 year guarantee

It is important to retain the retailer's receipt as proof of purchase. Staple your receipt to this back cover for future reference.

Please quote the following information if the product develops a fault. These numbers can be found on the base of the product.

Model no. Serial no.

All Morphy Richards products are individually tested before leaving the factory. In the unlikely event of any appliance proving to be faulty within 28 days of purchase, it should be returned to the place of purchase for it to be replaced.

If the fault develops after 28 days and within 12 months of original purchase, you should contact the Helpline number quoting Model number and Serial number on the product, or write to Morphy Richards at the address shown.

You may be asked to return a copy of proof of purchase.

Subject to the exclusions set out below (see Exclusions), the faulty appliance will then be repaired or replaced as appropriate and dispatched usually within 7 working days of receipt. If, for any reason, this item is replaced or repaired during the 1 year guarantee period, the guarantee on the new item will be calculated from original purchase date. Therefore it is vital to retain your original till receipt or invoice to indicate the date of initial purchase.

To qualify for the 1 year guarantee, the appliance must have been used according to the instructions supplied. For example, crumb trays should have been emptied regularly.



Disclaimer

Morphy Richards has a policy of continuous improvement in product quality and design. The company, therefore reserves the right to change the specification of its models at any time.

For electrical products sold within the European Community. At the end of the electrical products useful life, it should not be disposed of with household waste.

Please recycle where facilities exist. Check with your Local Authority or retailer for recycling advice in your country.

Health and safety

The use of any electrical appliance requires the following common sense safety rules. **Please read these instructions carefully before using the product.**

- **WARNING: This appliance incorporates a heating element which is subject to residual heat after use.**
- **WARNING: Misuse of the appliance could cause personal injury.**
- CAUTION: To prevent damage to the appliance, do not use alkaline cleaning agents when cleaning, use a soft cloth and mild detergent.
- This appliance can be used by children aged from 8 years and above if they have been given supervision or instruction concerning the use of the appliance in a safe way and if they understand the hazards involved. Cleaning and user maintenance shall not be made by children unless they are older than 8 and supervised. Keep the appliance and its cord out of the reach of children aged less than 8 years.
- For care and cleaning, refer to the relevant sections in these instructions.
- If the mains cable is damaged, it must be replaced by the manufacturer, its service agent or similarly qualified person in order to avoid a hazard.
- Appliances can be used by persons with reduced physical, sensory or mental capabilities or lack of experience and knowledge if they have been given supervision or instruction concerning use of the appliance in a safe way and understand the hazards involved.
- Children shall not play with the appliance.
- This appliance is intended to be used in household and similar applications such as: farm houses, by clients in hotels, motels and other residential type environments, and bed and breakfast type environments. It is not suitable for use in staff kitchen areas in shops, offices and other working environments in order to avoid a hazard.
- This product is not suitable for use in altitudes above 2000m.
- This appliance incorporates an earth connection for functional purposes only.
- If the supply cord is damaged, it must be replaced by the manufacturer, its service agent or similarly qualified persons in order to avoid a hazard.
- CAUTION: In order to avoid a hazard due to inadvertent resetting of the thermal cut-out, this appliance must not be supplied through an external switching device, such as a timer, or connected to a circuit that is regularly switched on and off by the utility.
- The coffee-maker shall not be placed in a cabinet when in use.

Exclusions

Morphy Richards shall not be liable to replace or repair the goods under the terms of the guarantee where:

- 1 The fault has been caused or is attributable to accidental use, misuse, negligent use or used contrary to the manufacturer's recommendations or where the fault has been caused by power surges or damage caused in transit.
 - 2 The appliance has been used on a voltage supply other than that stamped on the products.
 - 3 Repairs have been attempted by persons other than our service staff (or authorised dealer).
 - 4 The appliance has been used for hire purposes or non domestic use.
 - 5 The appliance is second hand.
 - 6 Morphy Richards reserves the right not to carry out any type of servicing under the guarantee at its discretion.
 - 7 Plastic filters for all Morphy Richards kettles and coffee makers are not covered by the guarantee.
 - 8 Batteries and damage from leakage are not covered by the guarantee.
- This guarantee does not confer any rights other than those expressly set out above and does not cover any claims for consequential loss or damage. This guarantee is offered as an additional benefit and does not affect your statutory rights as a consumer. Morphy Richards products are intended for household use only. See usage limitations within the location safety instructions.

Other safety considerations

Location

- Always locate your appliance away from the edge of the worktop.
- Ensure that the appliance is used on a firm, flat surface.
- Do not use the appliance outdoors or near water.

- **WARNING: Do not place the appliance onto a metal tray or metal surface whilst in use. Mains cable**
- Do not let the mains cable hang over the edge of the worktop where a child could reach it.
- Do not let the mains cable run across an open space e.g. between a low socket and a table
- Do not let the mains cable run across a cooker or other hot area which might damage the cable.
- The mains cable should reach from the socket to the base unit without straining the connections.

Personal safety

- **WARNING: To protect against fire, electric shock and personal injury do not immerse cord, plug and appliance in water or any other liquid.**
- Unplug from the outlet before cleaning.
- Allow to cool before putting on or taking off parts and before cleaning.
- Do not move the Coffee Maker while switched on.
- The use of attachments or tools not recommended or sold by Morphy Richards, may cause fire, electric shock or injury.
- Do not use the appliance for any use other than its intended purpose.
- Do not place the appliance on or near a hot gas or electric burner or in a heated oven.
- **WARNING: The appliance must not be immersed for cleaning.**
- **CAUTION: To prevent damage to the appliance, do not use alkaline cleaning agents when cleaning. Use a soft cloth and detergent.**

Electrical requirements

Should the fuse in the mains plug require changing, replace it with a fuse of the same rating as originally fitted.

WARNING: This appliance must be earthed.