

FS48755 MUK Rev 5

**morphyrichards**<sup>®</sup>  
smart ideas for your home



## 3 Tier Steamer

Please read and keep these instructions for future use

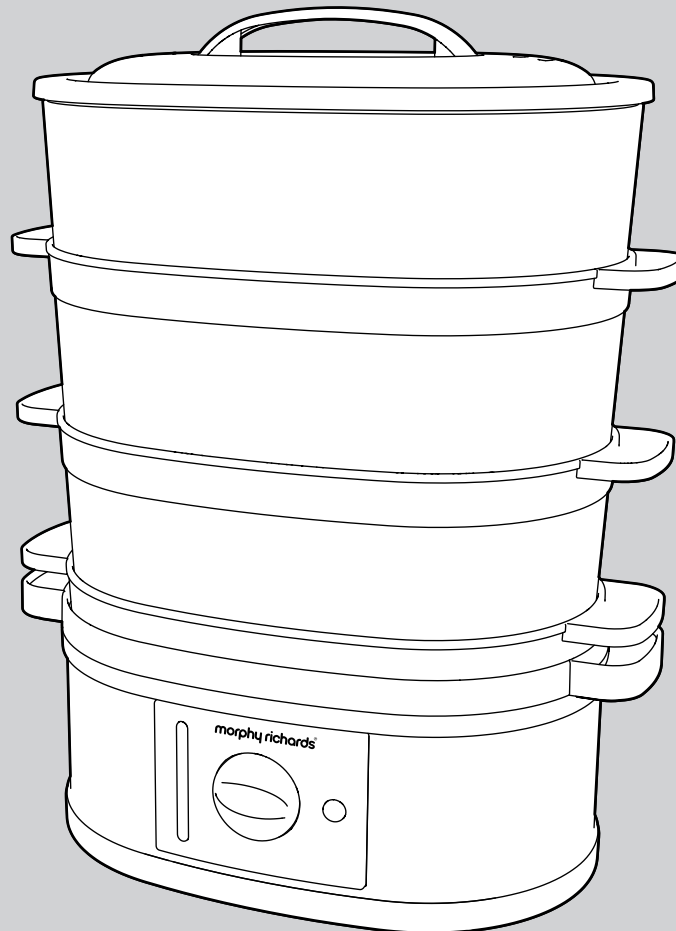

For competitions, product hints and tips and more join us at



[www.morphyrichards.co.uk/blog](http://www.morphyrichards.co.uk/blog)



[www.facebook.com/morphyrichardsuk](http://www.facebook.com/morphyrichardsuk)



[@loveyourmorphyrichards](https://twitter.com/loveyourmorphyrichards)

[www.morphyrichards.com](http://www.morphyrichards.com)

\* Register online for your 2 year guarantee. See the back of this instruction book for details, (UK and Ireland customers only).

## Health and Safety

The use of any electrical appliance requires the following common sense safety rules. Please read these instructions carefully before using the product.

- This appliance can be used by children aged from 8 years and above and persons with reduced physical, sensory or mental capabilities, or lack of experience and knowledge, if they have been given supervision or instruction concerning the use of the appliance in a safe way and understand the hazards involved.
- Children shall not play with the appliance.
- Cleaning and user maintenance shall not be made by children unless they are older than 8 and supervised.
- Keep the appliance and its cord out of reach of children less than 8 years.

### Location

- This appliance is intended to be used in household and similar applications such as:  
farm houses;

by clients in hotels, motels and other residential type environments; bed and breakfast type environments.

It is not suitable for use in staff kitchen areas in shops, offices and other working environments.

- Do not use outdoors or near water.
- Do not place directly under kitchen wall cupboards when in use, as it produces large amounts of steam. Avoid reaching over the steamer when in use.

### Mains cable

- The mains cable should reach from the socket to the base unit without straining the connections.
- Do not let the cable hang over the edge of the table or counter and keep it away from any hot surfaces.
- Do not let the cable run across an open space e.g. between a low socket and table.
- If the supply cable is damaged, it must be replaced by the manufacturer, its service agent or similarly qualified persons in order to avoid a hazard.

### Personal safety

- Do not touch hot surfaces. Use oven gloves or a cloth when removing the lid or handling hot containers as hot steam will escape.
- WARNING: To protect against fire, electric shock and personal injury, do not immerse cord, plugs, or appliance in water or other liquid.
- WARNING: Extreme caution must be used when moving the steamer when containing hot food, water, or other hot liquids.
- Appliances must not be immersed.
- Unplug from the socket when not in use, before putting on or taking off attachments, and before cleaning.

- Do not operate any appliance with a damaged lead or plug, or after an appliance has malfunctioned, or has been dropped or damaged in any way. Contact Morphy Richards for advice on examination, repair or electrical or mechanical adjustment.

- Do not fill above the maximum level. If the steamer is over-filled, boiling water may be ejected which can scald.

### Other safety considerations

- Do not use attachments or tools not recommended by Morphy Richards as this may cause fire, electric shock or injury.
- To open, lift the lids off towards yourself but tilted away from you.
- Do not use any steamer parts in a microwave or on any cooking/heated surfaces.
- Do not place on or near a hot gas or electric burner, or in a heated oven.
- Do not leave it in a damp and corrosive environment.
- Do not switch the steamer on unless it contains at least 1 cup of water, otherwise the steamer may be damaged.
- Always make sure the water does not fall below the minimum level.

### Treating scalds

- Run cold water over the affected area immediately. Do not stop to remove clothing, get medical help quickly.

### Electrical requirements

Check that the voltage on the rating plate of your appliance corresponds with your house electricity supply which must be A.C. (Alternating Current).

Should the fuse in the mains plug require changing, a 13 amp BS1362 fuse must be fitted.

**WARNING: This appliance must be earthed.**

## Product overview

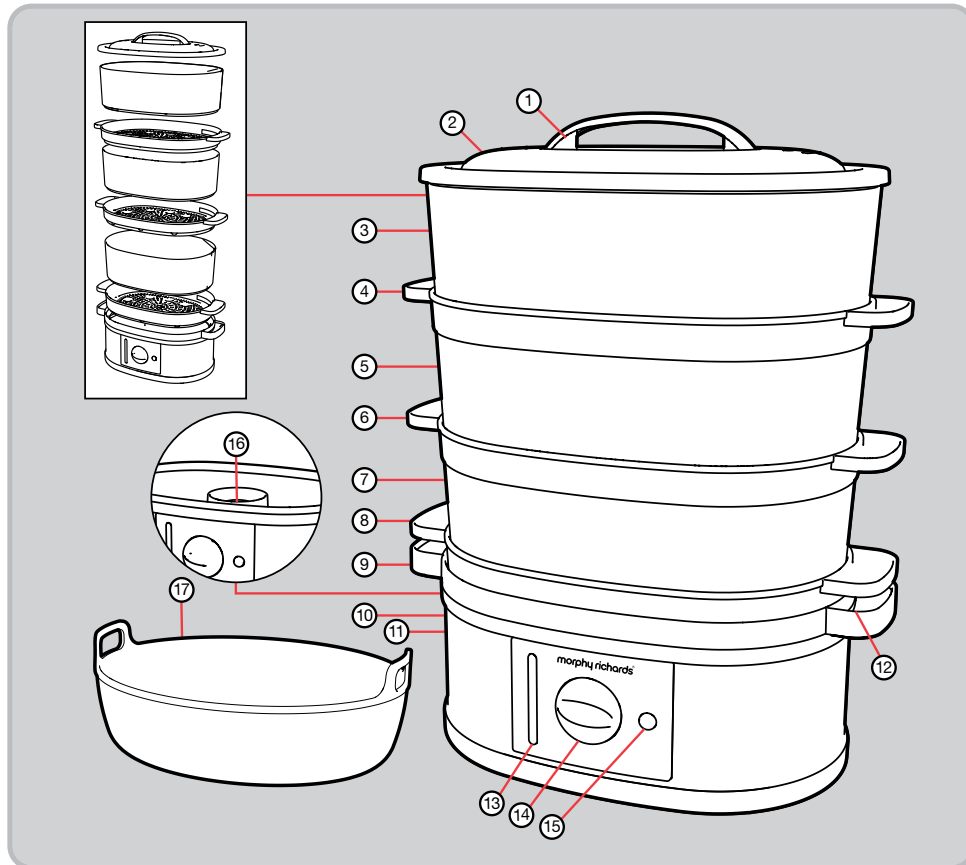

## Features

- |                 |                               |
|-----------------|-------------------------------|
| (1) Handle      | (10) Main Unit                |
| (2) Lid         | (11) Water Reservoir (Inside) |
| (3) Top Ring    | (12) Water Fill               |
| (4) Top Tray    | (13) Water Gauge              |
| (5) Middle Ring | (14) Timer                    |
| (6) Middle Tray | (15) Indicator Light          |
| (7) Bottom Ring | (16) Mantle Ring              |
| (8) Bottom Tray | (17) Rice Tray                |
| (9) Drip Tray   |                               |

## Before first use

Before using your steamer for the first time, wash all parts except the Main Unit (10).

## Configurations

Your steamer can be used to steam one two or three tiers of steaming bowls at the same time.

### Single tier

Use one tier for steaming one type of food, such as peeled potatoes. Take care to arrange the food so that some of the holes in the bottom of the tier remain clear, allowing steam to flow.

### Two tiers

Always place the largest pieces of food with the longest cooking time in the lowest tier. Place different foods in the upper and lower tiers, but as condensation will drip from the upper tier be sure the flavours complement each other.

### Three tiers

Always place the largest pieces of food with the longest cooking time in the lowest tier. Steaming times for food in the upper tiers are usually slightly longer so allow an extra 3-5 minutes due to a large volume of food being cooked and due to extra time being needed to reach temperature.

If foods with different cooking times are being steamed, start the food with the longest cooking time in the lowest tier. If steaming meat, fish or poultry together with vegetables, always place the meat, fish or poultry in the lowest tier so that juices from raw or partially cooked meat cannot drip onto other foods.

## Using your steamer

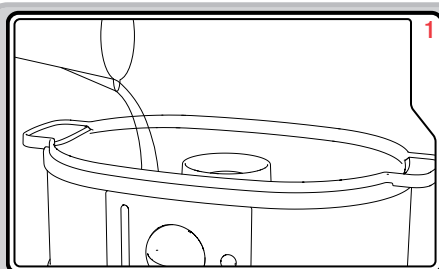

Fit the Mantle Ring (16) over the heater in the Water Reservoir (10). Fill with cold water to the maximum level. Do not add anything to the water.

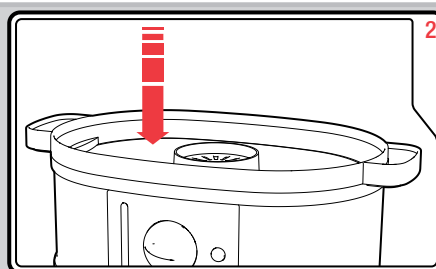

Place the Drip Tray (9) onto the Main Unit. Juices collected on the Drip Tray are ideal for use in stock or soup.

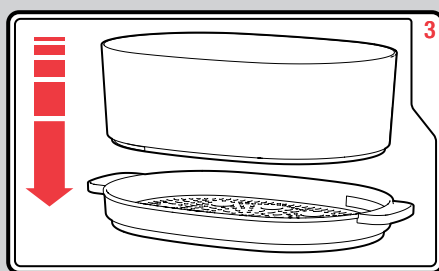

Assemble the tiers using the Steaming Rings (3),(5),(7) and Trays (4),(6),(8). Each layer is marked.

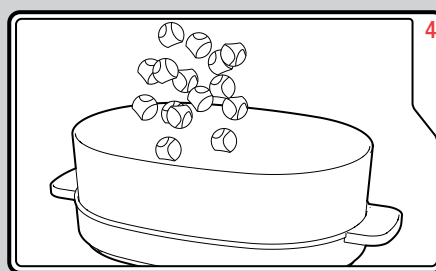

Place your food to be steamed into the required tiers

## Using your steamer

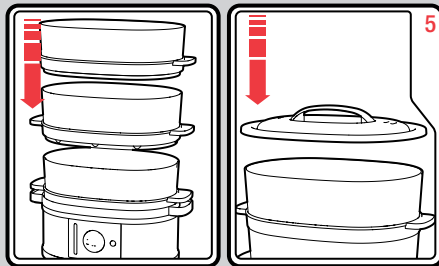

Place the tiers in order on the Main Unit (bottom, middle, top). Place the Lid (2) on the top tier.

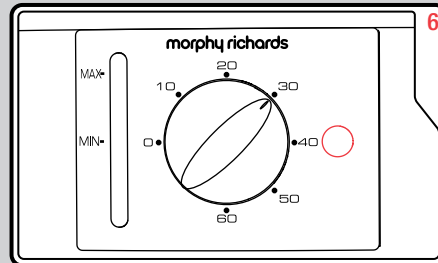

Plug into the mains. Set the Timer (14) for the desired cooking time. The Indicator Light (15) will illuminate and the steamer will begin cooking.

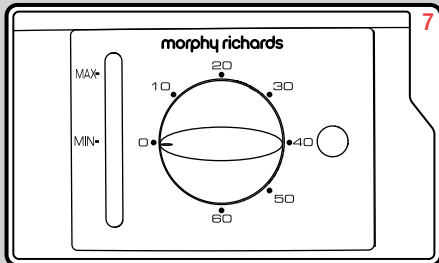

When finished the Indicator Light will extinguish and a bell will sound. The Steamer will stop automatically.

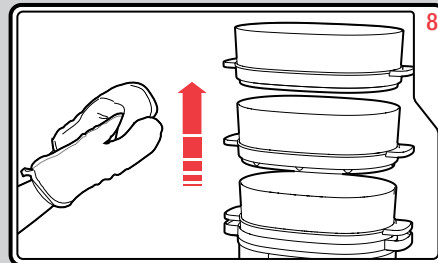

**WARNING: HOT STEAM, BEWARE OF HOT WATER DRIPPING.**

**USING OVEN GLOVES** promptly remove the tiers and serve the food. Do not remove the Drip Tray from the Main Unit until it has cooled completely. Water gathered on the Drip Tray can be used to make stock, if required, remove with care as water will be hot.

## Cooking Rice

The steamer comes with a container that allows you to cook rice to perfection.

1. Add rice and water to the Rice Tray (16) in equal proportions.
2. Place the Rice Tray with rice and water into a steaming tier.
3. Proceed as described previously for steaming.

## Refilling the Reservoir

If steaming for a long period it may be necessary to add extra water.

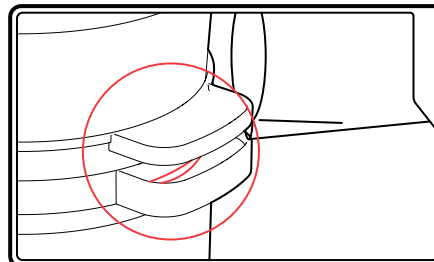

Fill with water through the Water Fill (12) using a suitable jug.

## Hints and tips

- Always ensure meat is placed below other food types.
- Steaming times stated in the cooking guide are only a guide. Times may vary depending on size of the food pieces, spacing of the food in the tier, quantity of food, freshness of food and

## Steaming Guide

- The cooking times shown below are only a guide and should be adjusted according to suit your tastes.
- While the majority of foods cook in less than 60 minutes, longer cooking times may require adding additional water to the water reservoir. Follow refill instructions. Remember to reset the timer as the steamer will switch off when the timer runs out.

Food	Bottom Tier	Middle Tier	Top Tier
• Rice	• 25-30 minutes	• 30-35 minutes	• 35-40 minutes
• Fish	• 8-10 minutes	• 10-15 minutes	• 15-18 minutes
• Poultry	• 25-28 minutes	• 28-30 minutes	• 30-35 minutes
• Vegetables	• 15-30 minutes	• 20-30 minutes	• 25-35 minutes
• Eggs	• 18 minutes	• 18-20 minutes	• 20-25 minutes

## Recipes

The recipes in this book have been designed and tested by Morphy Richards for use specifically in your steamer. The cooking times for the following recipes are a guide and will be affected by the size and freshness of the ingredients used. Always ensure food is thoroughly cooked before serving.

Recipes are designed for the maximum quantity stated. If you are reducing the portion sizes, please adjust the cooking times as appropriate.

personal preference. As you become familiar with the steamer, adjust the cooking times as necessary.

- A single tier of food steams faster than with 2 or 3 tiers in use. Therefore, the cooking time for a larger quantity of food will be longer.
- For best results, be sure pieces of food are similar in size. If pieces vary in size and layering is required, place smaller pieces on top.
- Do not crowd food in the tier or Rice Tray (17). Arrange the food with spaces between pieces to allow for maximum steam flow.
- Always use the drip tray to prevent drips splashing.



## Dolmades

Serves 25

### Ingredients:

- 4 sweet (long) red peppers, tops removed
- 1 med red onion, finely chopped
- 2tbsp lemon juice
- 1tsp mint sauce unsweetened
- 227g cooked white rice
- 1tsp cumin, ground
- 1 medium egg yolk
- 25 vine Leaves
- Salt and freshly ground black pepper

### To Serve:

- Lemon wedges
- Pickled chillies, to serve (optional)

### Method:

- 1 Place the chopped onion in a small saucepan with the lemon juice and simmer for 3-4 minutes, stirring until softened. Remove from the heat and stir in the mint sauce, cooked white rice, ground cumin and plenty of seasoning. Bind together with egg yolk.
- 2 Prepare 25 vine leaves as directed on the packet. Drain well and dry using absorbent kitchen paper.
- 3 Lay each vine leaf, vein side up, on a board. Place a spoonful of rice in the middle. Fold in two parallel sides of the leaf and roll up the leaf to encase the stuffing completely.
- 4 Place in the bottom tier and cook for 10 minutes until hot. Drain and serve warm with the lemon wedges and pickled chillies, if wished.



## Cod in parsley sauce

Serves 4

### Ingredients:

- 4x170g cod fillets
- 1tsp Lemon rind, finely grated
- 8 bay leaves
- 2tsp cornflour
- 142ml skimmed milk
- 142m fish or vegetable stock
- 113g low fat natural fromage frais
- 4tbsp parsley, chopped
- Juice of 1 small lemon
- Salt and freshly ground black pepper

### To Serve:

- Freshly steamed vegetables

### Method:

- 1 Place the fish in the bottom tier of the steamer, sprinkle with lemon rind, juice and black pepper. Add the bay leaves, cover and steam for 7-8 minutes until cooked through.
- 2 Meanwhile blend the cornflour with a little of the milk to form the paste. Pour into a saucepan with the rest of the milk and the stock. Bring to the boil, stirring, and cook gently for 1 minute until thickened.
- 3 Remove from the heat and cool for 5 minutes. Stir in the fromage frais and parsley. Season to taste and return to heat. Heat through over a low heat until hot. Do not allow to boil.
- 4 Drain the fish and discard the bay leaves. Place on warmed plates and spoon over the sauce.  
Serve with fresh vegetables.





## Chicken breasts with leek stuffing

Serves 4

### Ingredients:

- 4x142g chicken breasts, skinless
- 2 leeks, finely chopped
- 284ml chicken stock with Bovill
- 227g Quark soft cheese
- 1tsp fresh thyme, chopped
- Salt and freshly ground black pepper

### Method:

- 1 Make a deep horizontal cut nearly all the way through each chicken breast.
- 2 Place the leeks in a saucepan with the stock, bring to the boil then simmer for 10 minutes until the stock has evaporated and the leeks have softened. Leave to cool.
- 3 Once cold, mix the leeks with the cheese and thyme and season with salt and pepper. Stuff into the cuts in the chicken. Season the chicken and steam for 25 minutes.



## Lemon and thyme couscous with courgettes

Serves 4

### Ingredients:

- 4 skinless, boneless chicken breasts
- Finely grated zest and juice of 1 small orange
- 2tbsp maple syrup
- ¼tsp dried chilli flakes
- Salt and freshly ground black pepper

### Method:

- 1 Place the couscous in a bowl and pour over the hot stock. Add the lemon zest, lemon juice and thyme. Cover with cling film and leave for 5 minutes.
  - 2 Sprinkle the courgettes with salt and pepper and place in the bottom tier of the steamer.
  - 3 Line the middle tier with a clean J-cloth or muslin and spoon the couscous into the middle. Cover and steam for 8 minutes.
  - 4 Spoon the couscous into a bowl and stir in the courgettes followed by the cherry tomatoes.
- Serve hot or cold.





## Caribbean fish

Serves 4

### Ingredients:

- 4x170g red snapper

### Marinade:

- 1420ml water or fresh fish stock
- 2 bay leaves
- 1 sprig parsley, fresh
- 1 sprig thyme, fresh
- 1 onion, thinly sliced
- Juice of 2 limes
- 3 garlic cloves, crushed
- 4 allspice berries, crushed
- 1 chilli, de-seeded and chopped
- Salt and freshly ground black pepper

### Method:

- 1 Prepare the fish: Snip off the fins with scissors cut off the heads and scrape off the scales with a kitchen knife. Slit down the belly and remove the guts. Wash each fish thoroughly under running cold water, then pat dry with kitchen paper.
- 2 Mix all the marinade ingredients together. Place the fish in the shallow dish and pour the marinade over the top. Leave in a cool place for at least 30 minutes.
- 3 Remove the fish from the marinade and place in the bottom tier.
- 4 Steam for 18-20 minutes.

## Chicken pepper and lime skewers

Serves 4

### Ingredients:

- 4x142g chicken breasts, skinless cut into 2.5cm/1in pieces
- 1 garlic clove, crushed
- 1 lime juice and zest
- 8 bamboo skewers
- 1 red pepper, de-seeded and cut into 2.5/1in pieces
- 1tsp coriander, chopped
- Salt and freshly ground black pepper

### Method:

- 1 Place the chicken pieces in a bowl and stir in the garlic and juice and zest of the lime. Leave for 10 minutes.
- 2 Thread the chicken pieces onto the skewers alternating with the peppers.
- 3 Season with salt and pepper and place in the bottom tier and steam for 15 minutes.  
Just before serving, sprinkle with coriander.

## Seafood skewers

Serves 4

### Ingredients:

- 2 garlic cloves, crushed
- 2 lemon juice
- 2tsp basil, chopped
- 560g monkfish or king clip fillets, cut into 2.5/1in pieces
- 16 large raw prawns, peeled
- 8 bay leaves
- Salt and freshly ground black pepper

### Method:

- 1 Mix the garlic, lemon juice and basil together in a bowl. Mix in the fish and leave for 5 minutes.
- 2 Take 4 wooden skewers and thread the fish, fennel, prawns and bay leaves alternately onto each skewer.
- 3 Place the skewers in the bottom tier, season with a little salt and pepper and steam for 5-8 minutes.

## Spicy meatballs with tomato salsa

Serves 4

### Ingredients:

- 750g beef mince, extra lean
- 1 onion, finely chopped
- 1tbsp parsley, finely chopped
- 1 garlic clove, crushed
- 2tsp ground cumin
- 2tsp ground coriander
- 1/2tsp cinnamon
- 1/2tsp cayenne pepper
- 1 egg, beaten
- Salt and freshly ground black pepper

### Salsa:

- 8 tomatoes, peeled, de-seeded and diced
- 2 spring onions, finely chopped
- 2tbsp passata
- 1tbsp thyme, finely chopped

### Method:

- 1 Place all the ingredients for the meatballs in a large bowl and mix thoroughly. Season generously and with wet hands shapes the meat into golfball-sized rounds.
- 2 Place the meatballs in the bottom tier and steam for 20 minutes.
- 3 Mix together all the ingredients for the salsa and serve cold with the meatballs.

## Pork rolls with chinese vegetables and ginger

Serves 4

### Ingredients:

- 4x113g pork escalopes
- 1 garlic clove, crushed
- 2tbsp soy sauce
- 113g baby whole sweetcorn, halved lengthways
- 85g mangetout
- 4 spring onions
- 2.5cm/1in piece root ginger, peeled and finely sliced.

### Method:

- 1 Place the pork escalopes between two sheets of cling film and lightly beat out to 5mm/1/4in thickness. Place in shallow bowl.
- 2 Mix the garlic clove and soy sauce together and pour over the escalopes. Leave for 10 minutes to marinate.
- 3 Lay out the escalopes on a board and pile a small handful of the vegetables and ginger in the middle of each piece of meat. Roll up and secure with a toothpick.
- 4 Place in the bottom tier. Steam for 18-20 minutes.

## Care and Cleaning

**WARNING:** Allow steamer to cool before washing. Turn timer to off and unplug from the mains socket.

### Tiers (3)-(8), Lid (2), Drip Tray (9) and Mantle Ring (16)

The Rings and Drip Tray may be washed in a \ dishwasher (top rack only). Alternatively, wash in hot soapy water, rinse and dry thoroughly. Prolonged dishwasher use could discolour these parts. The Trays and Lids are dishwasher proof.

### Main Unit (10)

The Main Unit may be wiped with a clean, damp cloth. Wipe dry with a soft cloth.

Do not clean any part of the unit with abrasive cleaners e.g. scouring powders, steel wool or bleach.

## Contact us

### Helpline

If you are having a problem with your appliance, please call our Helpline, as we are more likely to be able to help than the retailer you purchased the item from.

Please have the product name, model number and serial number to hand when you call to help us deal with your enquiry quicker.

UK Helpline: 0844 871 0960

IRE Helpline: 1800 409 119

Spares: 0844 873 0726

### Talk To Us

If you have any questions or comments, or want some great tips or recipe ideas to help you get the most out of your products, join us online:

Blog: [www.morphyrichards.co.uk/blog](http://www.morphyrichards.co.uk/blog)

Facebook: [www.facebook.com/morphyrichardsuk](http://www.facebook.com/morphyrichardsuk)

Twitter: [@loveyourmorphy](https://twitter.com/loveyourmorphy)

Website: [www.morphyrichards.com](http://www.morphyrichards.com)

FS48755 MUK Rev 5 02/13

## Registering your 2 year guarantee

Your standard one year guarantee is extended for an additional 12 months when you register the product within 28 days of purchase with Morphy Richards. If you do not register the product with Morphy Richards within 28 days, your product is guaranteed for 1 year. To validate your 2 year guarantee register with us online at [www.morphyrichards.co.uk](http://www.morphyrichards.co.uk)

Or call our customer registration line

**UK 0844 871 0962**

**IRE 1800 409 119**

N.B. Each qualifying product needs to be registered with Morphy Richards individually.

Please note that the 2 year guarantee is only available in the UK and Ireland. Please refer to the one year guarantee for more information.

## Your 1 year guarantee

It is important to retain the retailer's receipt as proof of purchase. Staple your receipt to this back cover for future reference.

Please quote the following information if the product develops a fault. These numbers can be found on the base of the product.

Model no.

Serial no.

All Morphy Richards products are individually tested before leaving the factory. In the unlikely event of any appliance proving to be faulty within 28 days of purchase, it should be returned to the place of purchase for it to be replaced.

If the fault develops after 28 days and within 12 months of original purchase, you should contact the Helpline number quoting Model number and Serial number on the product, or write to Morphy Richards at the address shown.

You may be asked to return a copy of proof of purchase.

Subject to the exclusions set out below (see Exclusions), the faulty appliance will then be repaired or replaced as appropriate and dispatched usually within 7 working days of receipt.

If, for any reason, this item is replaced or repaired during the 1 year guarantee period, the guarantee on the new item will be calculated from original purchase date. Therefore it is vital to retain your original till receipt or invoice to indicate the date of initial purchase.

To qualify for the 1 year guarantee, the appliance must have been used according to the instructions supplied. For example, crumb trays should have been emptied regularly.

## Exclusions

Morphy Richards shall not be liable to replace or repair the goods under the terms of the guarantee where:

- 1 The fault has been caused or is attributable to accidental use, misuse, negligent use or used contrary to the manufacturer's recommendations or where the fault has been caused by power surges or damage caused in transit.
  - 2 The appliance has been used on a voltage supply other than that stamped on the products.
  - 3 Repairs have been attempted by persons other than our service staff (or authorised dealer).
  - 4 The appliance has been used for hire purposes or non domestic use.
  - 5 The appliance is second hand.
  - 6 Morphy Richards reserves the right not to carry out any type of servicing under the guarantee at its discretion
  - 7 Plastic filters for all Morphy Richards kettles and coffee makers are not covered by the guarantee.
  - 8 Batteries and damage from leakage are not covered by the guarantee.
- This guarantee does not confer any rights other than those expressly set out above and does not cover any claims for consequential loss or damage. This guarantee is offered as an additional benefit and does not affect your statutory rights as a consumer. Morphy Richards products are intended for household use only. See usage limitations within the location safety instructions.

## Disclaimer

Morphy Richards has a policy of continuous improvement in product quality and design. The company, therefore reserves the right to change the specification of its models at any time.



For electrical products sold within the European Community. At the end of the electrical products useful life, it should not be disposed of with household waste.

Please recycle where facilities exist. Check with your Local Authority or retailer for recycling advice in your country

**IF YOU ARE HAVING A PROBLEM  
WITH ONE OF OUR PRODUCTS, CALL  
OUR HELPLINE:**

**UK: 0844 871 0960  
EIRE: 1800 409 119  
SPARES: 0844 873 0726**

**morphy richards**

The After Sales Division  
Morphy Richards Ltd  
Mexborough, South Yorkshire,  
England, S64 8AJ

Helplines (office hours)  
UK 0844 871 0960  
Spare Parts 0844 873 0726  
Republic of Ireland 1800 409 119  
[www.morphyrichards.com](http://www.morphyrichards.com)

