

SC460009 MUK Rev 2

morphy richards[®]
smart ideas for your home



Stew & Stir Slow Cooker

 Please read and keep these instructions for future use

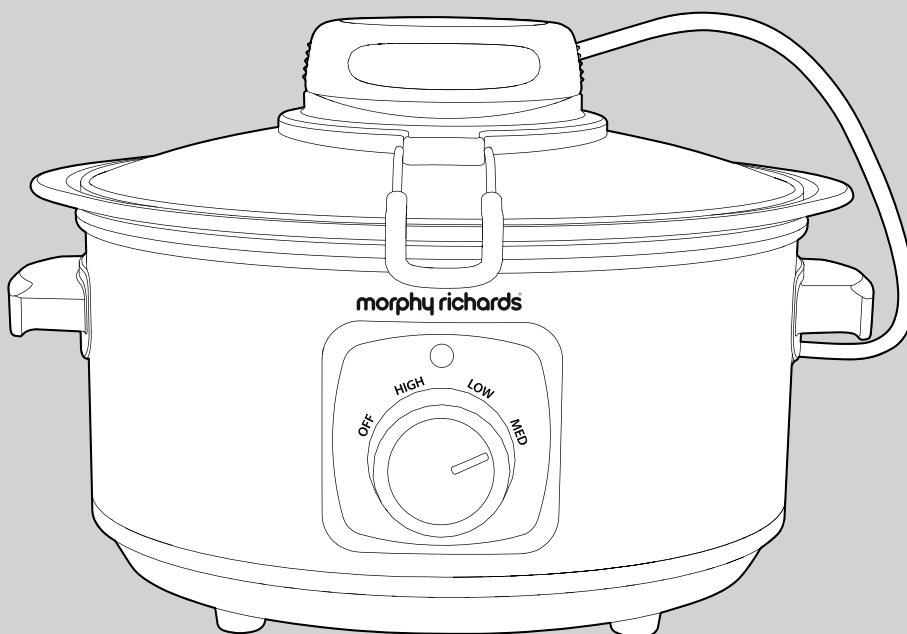

For competitions, product hints and tips and more join us at



www.morphyrichards.co.uk/blog



www.facebook.com/morphyrichardsuk



[@loveyourmorphy](https://twitter.com/loveyourmorphy)

www.morphyrichards.com

* Register online for your 2 year guarantee. See the back of this instruction book for details (UK and Ireland customers only).

Health And Safety

The use of any electrical appliance requires the following common sense safety rules. Please read these instructions carefully before using the product.

- This appliance can be used by children from 8 years and above if they have been given supervision or instruction concerning use of the appliance in a safe way and if they understand the hazards involved. Cleaning and user maintenance shall not be made by children unless they are older than 8 and supervised. Keep the appliance and its cord out of reach of children aged less than 8 years. Children shall not play with the appliance.
- Appliances can be used by persons with reduced physical, sensory or mental capabilities or lack of experience and knowledge if they have been given supervision or instruction concerning use of the appliance in a safe way and understand the hazards involved.
- This appliance is intended to be used in household and similar applications such as: farm houses, by clients in hotels, motels and other residential type environments, and bed and breakfast type environments.
- If the supply cable is damaged, it must be replaced by the manufacturer, its service agent or similarly qualified persons in order to avoid a hazard.
- **WARNING:** Misuse of appliance could cause personal injury.
- **WARNING:** Do not immerse the Base or Stirring Control Panel in water for cleaning.
- The appliance is not intended to be operated by means of an external timer or separate remote system.

Location

- Always locate your appliance away from the edge of the worktop.
- Ensure that the appliance is used on a firm, flat, heat resistant surface.

Mains cable

- The mains cable should reach from the socket to the appliance without straining the connections.
- Do not let the mains cable hang over the edge of the worktop or open space where a child could reach it.
- Do not let the cable run across a cooker or hot area which might damage the cable.

Personal safety

- **WARNING: Do not touch the top of the appliance or other hot parts during or after use, use handles or knobs. The heating element surface is subject to residual heat after use.**
- To protect against the risk of electrical shock do not put base in water or in any other liquid.
- Do not touch hot surfaces. Use oven gloves or a cloth when removing lid or handling hot containers.
- Extreme caution must be used when moving an appliance containing hot food, water, or other hot liquids.



Other safety considerations

- Do not switch on the Slow Cooker if the Cooking Pot is empty.
- Allow the Glass Lid and Cooking Pot to cool before immersing in water.
- Never cook directly in the Base Unit. Use the Cooking Pot.
- Do not use the Cooking Pot or Glass Lid if cracked or chipped.
- The Glass Lid and Cooking Pot are fragile. Handle them with care.
- The use of attachments or tools not recommended by Morphy Richards may cause fire, electric shock or injury.
- Do not place on or near a hot gas or electric burner or in a heated oven.
- Unplug from the socket when not in use, before putting on or taking off attachments, and before cleaning.
- Avoid spillage onto the Stirring Power Cable (4).

Electrical requirements

Check that the voltage on the rating plate of your appliance corresponds with your house electricity supply which must be A.C. (Alternating Current). Should the fuse in the mains plug require changing, a 3 amp BS1362 fuse must be fitted.

WARNING: This appliance must be earthed.

Introduction

Thank you for purchasing your new Morphy Richards Stew & Stir Slow Cooker.

Your Slow Cooker will allow you to create an extensive selection of meals with the added benefit of being able to automatically stir your food during cooking. Combine this with your slow cooker and you can create delicious dishes with richer, fuller flavours.

Contents

Health And Safety	2
Introduction	3
Product Overview	4
Features	4
Before First Use	5
Assembling Your Stirring Lid	5
Using Your Slow Cooker	6
Using the Stirring Function	7
Cleaning Your Slow Cooker	8
Care and Cleaning	8
Handling The Cooking Pot	9
Handling The Glass Lid	9
Handling The Stirring Paddle	9
Foods For Slow Cooking	9
Slow Cooking Tips	9
Caring For The Glass Lid, Stirring Paddle and Cooking Pot	10
Recipes	11
Troubleshooting	19
Contact Us	19
Guarantee	20

Product Overview

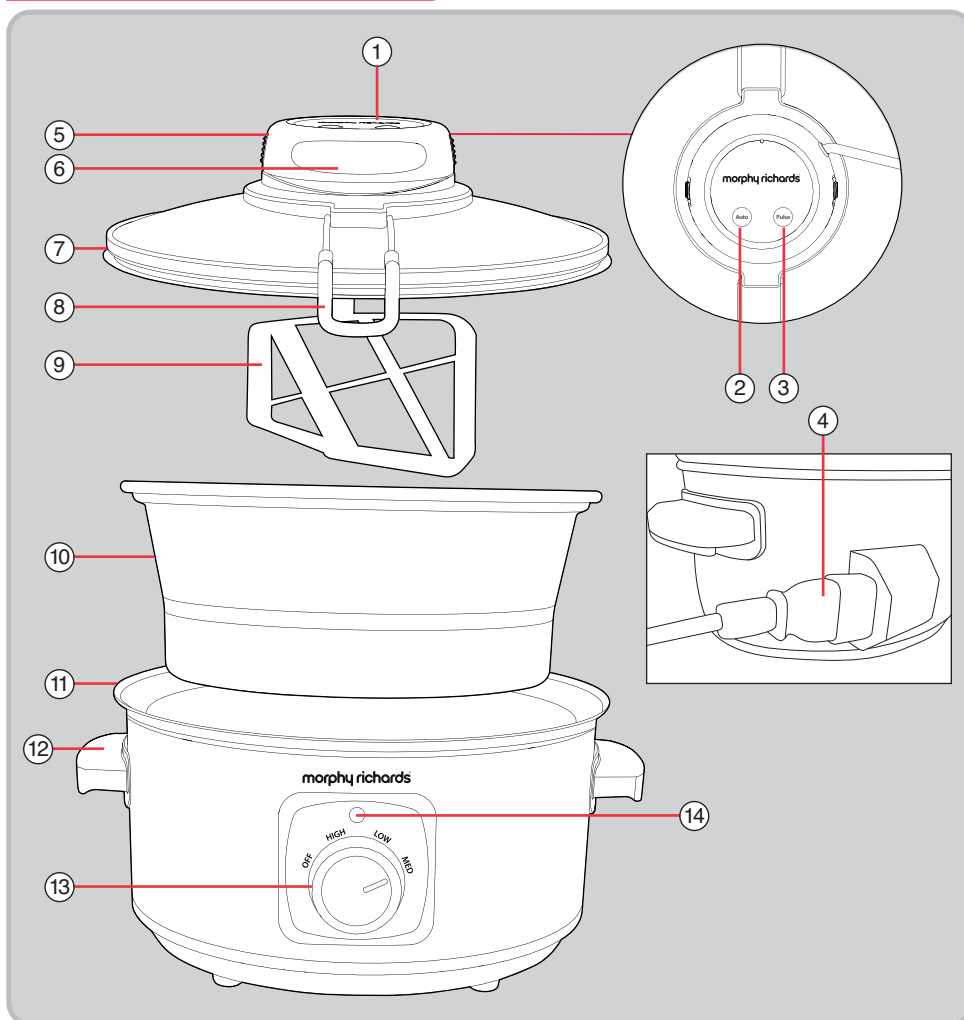

Features

- | | |
|----------------------------|----------------------|
| (1) Stirring Control Panel | (8) Lid Clips |
| (2) Auto Button | (9) Stirring Paddle |
| (3) Pulse Button | (10) Cooking Pot |
| (4) Stirring Power Cable | (11) Base Unit |
| (5) Lid Release Buttons | (12) Base Handles |
| (6) Lid Handle | (13) Control Knob |
| (7) Glass Lid | (14) Indicator Light |

Before First Use

DO NOT IMMERSE THE BASE UNIT (11) AND THE STIRRING CONTROL PANEL (1) IN WATER. Wash the Glass Lid (7), Cooking Pot (10) and Stirring Paddle (9) in hot, soapy water. Rinse and dry.

Note

The Cooking Pot (10) is not suitable for use on an induction hob.

Assembling Your Stirring Lid

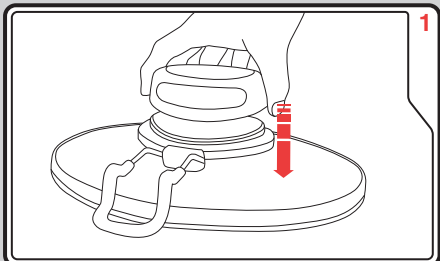

Slot the Stirring Control Panel (1) into the Glass Lid (7) until it clicks into place.

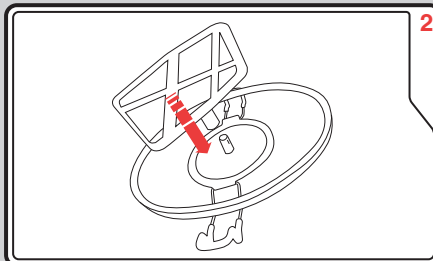

Attach the Stirring Paddle (9) to the bottom of the Stirring Control Panel (1) by pushing firmly onto the shaft. When aligned it clicks into place. Only fit and use the Stirring Paddle (9) for certain recipes.

Using Your Slow Cooker

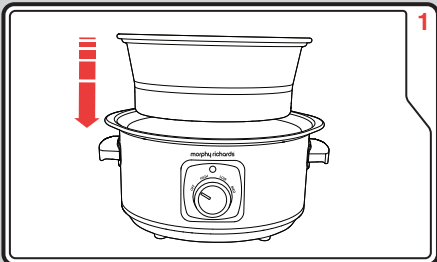

Place the Cooking Pot (10) into the Base Unit (11).

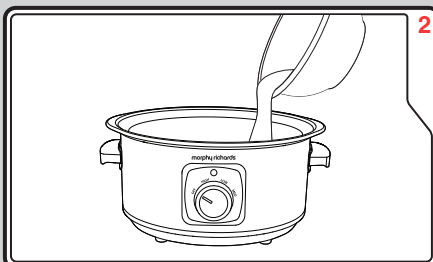

Add the ingredients to the Cooking Pot (10). Ingredients can be sautéed in a pan before adding to the Cooking Pot (10).

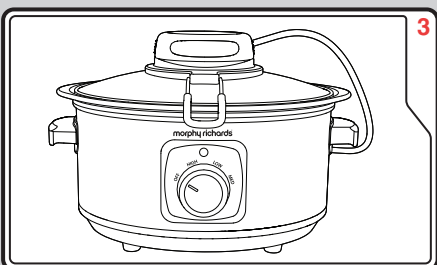

Place the Glass Lid (7) on the Base Unit (11) and fasten the Lid Clips (8) securely under the Glass Lid (7) until they click into place.

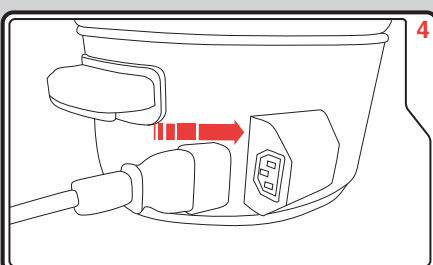

Plug in the Stirring Power Cable (4) to the Base Unit (11). Plug the Slow Cooker into the mains.

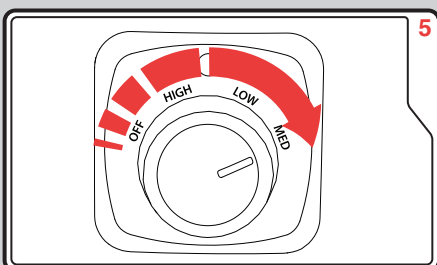

Select Low, Medium or High setting on the Control Knob (13) to start slow cooking. The Indicator Light (14) will illuminate.

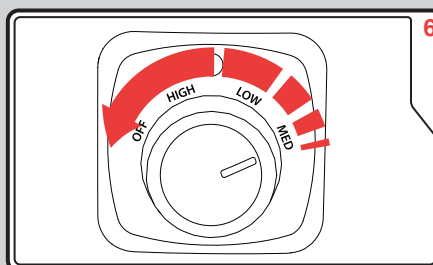

When cooking has finished, (refer to the cooking guide on page 11) turn the Control Knob (13) to Off. The Indicator Light (14) will switch off.

Using the Stirring Function

After you have selected your cooking setting you may want to choose the option to stir your food.

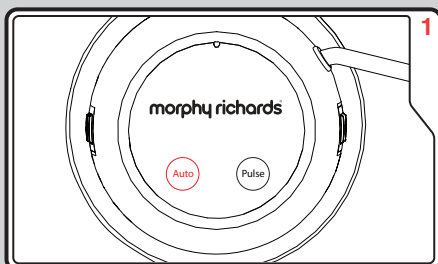

Press the Auto Button (2).

Auto stir operates after your food has been cooking for 2 hours. Auto will then stir for 5 minutes every 30 minutes until your slow cooker is switched off.

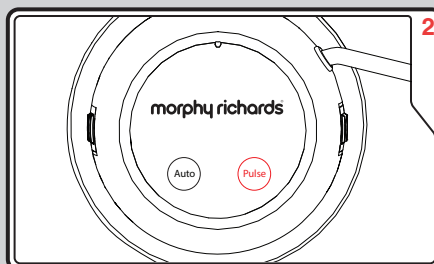

Press the Pulse Button (3) for an instant 1 minute stir.

Pulse setting is used to give your cooking a quick stir from time to time while still holding in heat and flavour. Pulse is not an automatic stirring function.

PLEASE NOTE: Do not lift the Glass Lid (7) with the Lid Release Buttons (5) pressed. Lift the Glass Lid (7) using the Lid Handles (6).

DO NOT fit the Stirring Paddle (9) when using recipes that contain large ingredients eg. joint of meat, chicken portions, spare ribs etc. Refer to the recipe guide on page 11 together with recipes for use with the Stirring Paddle (9).

Before Cleaning

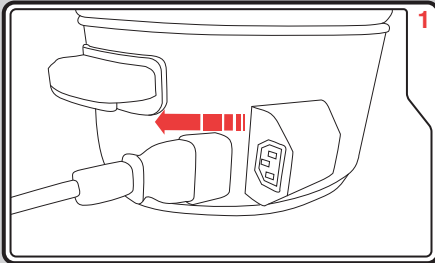

Unplug the Slow Cooker from the mains and unplug the Stirring Power Cable (4) from the Base Unit (11).

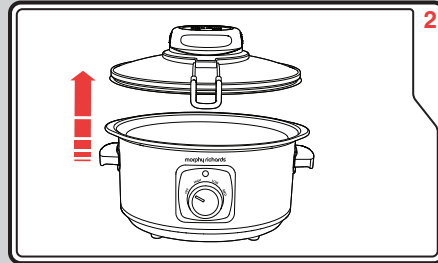

Unclip the Lid Clips (8) from the Base Unit (11) and remove the Glass Lid (7).

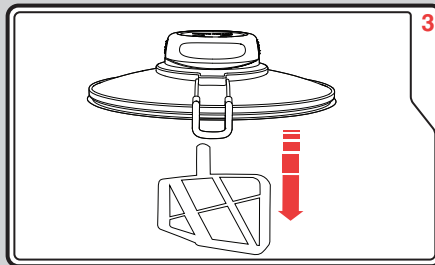

Pull the Stirring Paddle (9) off the Stirring Control Panel (1).

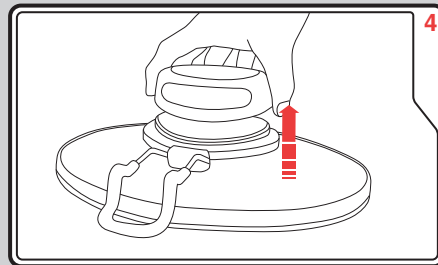

Press and hold the Lid Release Buttons (5) and pull the Stirring Control Panel (1) away from the Glass Lid (7).

Care And Cleaning

- Turn off and unplug the Slow Cooker from the mains. Allow to cool completely before cleaning.
- Do not use metal utensils or abrasive cleaners when cleaning.
- Remove the Glass Lid (7), Cooking Pot (10) and Stirring Paddle (9) and clean in hot soapy water.
- Wipe the sides of the Base Unit (11) with a damp cloth.
- The Cooking Pot (10) is dishwasher safe.

DO NOT IMMERSE THE BASE UNIT OR THE STIRRING CONTROL PANEL IN WATER.

THE STIRRING PADDLE AND LID ARE NOT DISHWASHER SAFE.

Handling The Cooking Pot

- **WARNING:** The Cooking Pot (10) will become very hot when in use.
- Do not use metal utensils to stir food in the Cooking Pot (10) as this will scratch and remove the non stick coating. Use either wood or silicone plastic utensils.
- **WARNING:** The Lid Handle (6), Base Unit (11) and Cooking Pot (10), as well as the outside of the Base Unit (11), all become hot during cooking. Always use oven gloves when handling ANY part of the Slow Cooker during cooking.

Handling The Glass Lid

- When removing the Glass Lid (7), tilt so that opening faces away from you to avoid being burned by steam.
- Do not hold the Glass Lid (7) with the Lid Release Buttons (5) pressed. This will cause the Stirring Control Panel to fall away from the Lid. Use the Lid Handle (6).

Handling The Stirring Paddle

- Take care when removing the Stirring Paddle (9), the food residue may be hot.

Foods For Slow Cooking

- Most foods are suited to slow cooking methods, however there are a few guidelines that need to be followed.
- Ensure all frozen ingredients are thoroughly defrosted prior to cooking.
- Cut root vegetables into small, even pieces, as they take longer to cook than meat. They can be gently sauteed for 2-3 minutes before slow cooking. Ensure that root vegetables are always placed at the bottom of the Cooking Pot (10) and all ingredients are immersed in the cooking liquid.
- Trim all excess fat from meat before cooking, as the slow cooking method does not allow fat to evaporate.
- If adapting an existing recipe from conventional cooking, you may need to reduce the amount of liquid used. Liquid will not evaporate from the Slow Cooker to the same extent as conventional cooking.
- Never leave uncooked food at room temperature in the Slow Cooker.
- Uncooked kidney beans must be soaked overnight and boiled for at least 10 minutes to remove toxins before use in a Slow Cooker.
- Insert a meat thermometer into joints of roasts, hams or whole chickens to ensure they are cooked to the desired temperature.
- Do not use the Slow Cooker to reheat food.

Slow Cooking Tips

- The Slow Cooker must be at least half full for best results.
- Slow cooking retains moisture. If you wish to reduce liquid, remove the Lid after cooking and turn the control to High. Reduce the moisture by simmering for 30 to 45 minutes.
- If cooking soups, leave 5 cm gap from the rim of the Cooking Pot (10) and the food surface to allow for simmering.
- Removing the Glass Lid (7) will allow heat to escape, reducing the efficiency of your Slow Cooker and increasing the cooking time. If you remove the Lid to stir or add ingredients, you will need to allow 10-15 minutes extra cooking time for each time you remove the Glass Lid (7).
- Many things can affect how quickly a recipe will cook, including water and fat content, initial temperature of the food and the size of the food. Check food is properly cooked before serving.

- Many recipes will take several hours to cook. If you don't have time to prepare food in the morning, prepare it the night before, storing the food in a covered container in the fridge. Transfer the food to the Cooking Pot (10) and add boiling liquid/stock. In most of the recipes in this book, the meat ingredients are browned first to improve their appearance and flavour.
- Most meat and vegetable recipes require 8-10 hours on Low, 6-8 hours on Medium or 4-6 hours on High.
- Some ingredients are not suitable for slow cooking. Pasta, seafood, milk and cream should be added towards the end of the cooking time.
- Pieces of food cut into small pieces will cook quicker. A degree of 'trial and error' will be required to fully optimise the potential of your Slow Cooker.
- All food should be covered with a liquid, gravy or sauce. In a separate pan or jug, prepare your liquid, gravy or sauce and completely cover the food in the Cooking Pot (10).
- When cooking joints of meat, ham, poultry etc, the size and shape of the joint is important. Try to keep the joint in the lower 2/3 of the pot. If necessary, cut into two pieces. Joint weight should be kept within the maximum limit see recipe for guidance.
- For ham and brisket fill with hot water to just cover 2/3 of the depth of the joint. For beef, pork or poultry cover to 1/3 depth
- Extreme caution must be used when moving an appliance containing hot food, water, or other hot liquids.

Caring For The Glass Lid, Stirring Paddle & Cooking Pot

- Please handle the Glass Lid (7), Cooking Pot (10) and Stirring Paddle (9) carefully to ensure long life.
- Avoid sudden, extreme temperature changes to the Glass Lid (7). For example, do not place a hot lid into cold water or onto a wet surface.
- Avoid hitting the Glass Lid (7) against any hard surfaces.
- Do not use the Glass Lid (7) if chipped, cracked or severely scratched.
- Do not use abrasive cleansers or metal scouring pads.
- Never heat the Cooking Pot (10) when empty.
- Never place the Glass Lid (7) or Cooking Pot (10) under a grill, in the oven, in a microwave or toaster oven.
- Never place the Lid directly on a burner or hob.
- **Do not use metal utensils to stir food in the Cooking Pot (10) as this will scratch and remove the non stick coating. Use either wooden or silicone plastic utensils.**

Recipes



We have developed recipes for you to use in your Stew & Stir Slow Cooker. From soups for starters, curries for mains and pineapple compote for dessert, there are choices for all tastes.

Should you want to increase or decrease the cooking time, please refer to the cooking guide below. Please note that these cooking times are for guidance only and may vary depending on food type and personal tastes.

The recipes are based on the maximum working volume of the slow cooker. The working volume of the 3.5L model is 2.5 litres / 4½ pts. The working volume of the 6.5L model is 5 litres / 10½ pts. This allows a 2cm space between the top of the pot and the food.

If you are cooking a joint of meat, chicken portions, spare ribs etc. Refer to each individual recipe. Make sure the stirring paddle is removed before attaching the Lid.

Cooking Guide

Cook on High

- 4-6 hours

Cook on Medium

- 6-8 hours

Cook on Low

- 8-10 hours

Mains - Auto Stir Recipes

Thai Green Chicken Curry

Ingredients:

3.5L	6.5L	
• 1 tbsp	1½ tbsp	Olive oil
• 150g	225g	Thai green curry paste
• 950g	1.5kg	Chicken breast
• 1	1½	Zest and juice lime
• 300ml	400ml	Coconut milk
•		Salt and pepper to taste

Garnish:

Fresh chopped coriander

Method:

- 1 Cut the chicken into chunks and set aside.
- 2 Heat the oil in a Frying Pan on the hob over a medium heat then add the curry paste and sauté, stirring with a wooden spoon for 1 minute.
- 3 Add the chicken and cook for a few minutes.
- 4 Add the ingredients (with the exception of the coriander) to the Cooking Pot, select High setting and Auto Stir and cook for 4 hours, 6 hours on Medium or 8 hours on Low setting.
- 5 Check the seasoning, serve garnished with chopped coriander, boiled rice and Naan bread.

NOTE: For best results use diced chicken breast as opposed to diced chicken thighs.

Turkey Tacos

Ingredients:

3.5L	6.5L	
• 750g	1.5kg	Turkey thigh mince
• 150g	300g	Onion, chopped
• 2	4	Cloves garlic, crushed
• 2 - 3 tbsp	4-5½ tbsp	Piri Piri seasoning (see note below)
• 500g	1kg	Passata
• 1-2 tbsp	1-2 tbsp	Cornflour (more if necessary to achieve desired consistency)

To serve

- Taco shells
- Shredded lettuce, diced tomatoes
- Grated cheddar cheese
- Sour cream (optional)

Method:

- 1 Heat a Frying Pan over medium heat on the hob, add the mince and cook, stirring occasionally until it changes colour.
 - 2 Add the onions and garlic and sauté for a few minutes. Add the Piri Piri seasoning and stir over the heat to release the flavours then add the passata. Add the ingredients to the Cooking Pot.
 - 3 Cook on the desired setting with Auto Stir. 4-6 hours on High, 6-8 hours on Medium or 8-10 hours on Low.
 - 4 Just before serving, thicken if necessary as follows: put cornflour into a small bowl and add equal amount of water, mix until smooth and then add to the Cooking Pot and stir well. Use more cornflour and water if necessary to achieve the desired consistency. Turn the Control Knob to High and stir for a few minutes with a wooden spoon until thickened.
 - 5 Serve in taco shells, with chopped salad and grated cheese.
- Note: Some brands of Piri Piri seasoning are spicier than others. Be guided by the instructions on the packaging.
 - Turkey thigh mince gives a better flavour than turkey breast mince.

Barbecue Pork Stew

Ingredients:

3.5L	6.5L	
• 1 tbsp	1½ - 2 tbsp	Olive oil
• 800g	1.5kg	Pork leg, diced
• 150g	300g	Onion, chopped
• 3 level tsp	6 level tsp	Mustard powder
• 2 level tsp	4 level tsp	Ground ginger
• 4 heaped tbsp	8 heaped tbsp	Light brown soft sugar
• 3 tbsp	4½ tbsp	Soy sauce
• 300ml	500ml	Dry cider
• 1 tbsp	1 tbsp	Cornflour (optional)
• Salt and pepper, to taste		

Method:

- 1 Heat the oil in the Frying Pan over a medium heat and brown half the diced pork at a time. When ready, remove and set aside and then repeat with the remaining meat.
- 2 Add the onions with the meat and gently sauté for a few minutes.
- 3 Meanwhile mix together the mustard, ginger and sugar in a bowl, add the soy sauce and stir well until smooth and then add the dry cider.
- 4 Pour the mixture into the Cooking Pot, season with salt and pepper, transfer the Pot to the Base Unit and cover with the Lid.
- 5 Select High setting and Auto stir and cook for 4 – 6 hours, 6-8 hours on Medium or 8-10 hours on Low.
- 6 When cooking is complete, thicken the sauce if desired by mixing the cornflour with 1 tbsp cold water until smooth, add 1 tbsp of the cooking liquid and then return to the Cooking Pot. This can be done 30 minutes before the end of cooking if preferred.
- 7 Serve with jacket or mashed potatoes.

Vegetarian - Auto Stir Recipes

Red Lentil Dal

Ingredients:

3.5L	6.5L	
• 1½ tsp	2¼ tsp	Mustard seeds
• 1½ tsp	2¼ tsp	Cumin seeds
• ¾ tsp	1¼ tsp	Fennel seeds
• 400g	600g	Canned chopped tomatoes
• 150g	225g	Onion, finely chopped
• 750ml	1.2L	Water
• 320g	480g	Red lentils, rinsed
• 8g	12g	Fresh ginger, grated
• ¾	1¼ tbsp	Turmeric
• 1	1	Bay leaf
• pinch	pinch	Salt and pepper

Garnish:

Fresh Coriander

Method:

- 1 Place the mustard, cumin and fennel seeds into the Frying Pan and stir over a low heat on the hob for a few minutes.
- 2 Place all the ingredients into the Cooking Pot, stir well and then transfer the Cooking Pot into the Base Unit. Cover with the Lid, select Auto Stir and cook for 3½ - 4 hours on the High setting, 5-6 hours on Medium, or 6½ - 8 hours on Low.
- 3 When ready, check the seasoning, add salt and pepper if necessary and then sprinkle on chopped coriander and serve with naan bread or rice.

Moroccan Vegetable Tagine

Ingredients:

3.5L	6.5L	
• 1 tbsp	1½ tbsp	Olive oil
• 100g chopped	150g	Onion, finely
• 2 crushed	3	Cloves garlic,
• 150g	225g	Carrot, small dice
• 300g	450g	Sweet potatoes, small dice
• 2 heaped tbsp	3 heaped tbsp	Ras el hanout paste
• 12g	18g	Fresh ginger, finely grated
• 2 tbsp	3 tbsp	Tomato puree
• 400g	600g	Canned chickpeas, rinsed and drained
• 75g	100g	Dried apricots, quartered
• 450ml	625ml	Vegetable stock
• 1	2	Cinnamon sticks

Garnish:

Chopped mint, lemon

Method:

- 1 Heat the oil in the Frying Pan on the hob over medium heat and gently sauté the onion and garlic for a couple of minutes, stirring occasionally with a wooden spoon.
 - 2 Add the diced carrots and sweet potatoes and cook for about 3 minutes, stirring occasionally. Then add the ras el hanout paste and stir for a minute.
 - 3 Add the remaining ingredients to the Frying Pan and stir well. Transfer the Cooking Pot to the Base Unit, cover with the Lid, select High setting and Auto Stir and cook for 4 hours. If preferred cook for 6 hours on Medium or 8 hours on Low.
 - 4 To serve, remove the cinnamon, sprinkle with chopped mint, a squeeze of lemon and accompany with couscous or bulgur wheat.
- Note: If preferred you can add the chickpeas 30 minutes before the end of cooking.
 - For a change harissa paste works well instead of Ras el hanout. Use the same quantity of paste.

Dessert - Auto Stir Recipe

Pineapple and Ginger Compote

Use the stem ginger preserved in syrup.
If liked replace some or all of the water with rum.

Ingredients:

3.5L	6.5L	
• 750g	1500g	Pineapple
• 50g	100g	Stem ginger pieces, finely chopped
• 4 tbsp	8 tbsp	Stem ginger syrup
• 35g	70g	Light brown soft sugar
• ½	1	Cinnamon stick
• 75ml	200ml	Water

Method:

- 1 Remove the core and skin from the pineapple and then chop into bitesize pieces, approximately 15-20mm cubes.
- 2 Place all ingredients into the Cooking Pot and stir with a wooden spoon. Cover with the Glass Lid, select High setting and Auto Stir and cook for 3 hours.
- 3 Remove the cinnamon stick and serve warm or cold with fresh cream or ice cream.

Manual Recipes - Soup

Vegetable Soup

Ingredients:

3.5L	6.5L	
• 30g	60g	Butter
• 1.25kg	1.8kg	Mixed vegetables, e.g. potatoes, onions, carrots, parsnips, celery, leeks, tomatoes
• 1.1L	2L	Vegetable stock
• 1 tsp	1 tsp	Mixed herbs
• pinch	pinch	Salt and pepper
• 30g	60g	Flour

Method:

- 1 Peel, wash and cube or slice all the vegetables.
- 2 Melt butter in a Frying Pan and gently sauté the vegetables on the hob for 2-3 minutes.
- 3 Add the hot stock. Stir well and bring to the boil. Season to taste and add mixed herbs.
- 4 Transfer the Cooking Pot.
- 5 Cover with the Glass Lid and cook on the desired setting.
- 6 Cool and liquidise the soup.
- 7 Reheat on the hob, thickening the soup with a paste made with flour and water.

Manual Recipes - Poultry

Chicken in White Wine

Ingredients:

3.5L	6.5L	
• 4	10	Chicken breasts, skinned
• 20g	40g	Butter
• 1	2	Finley chopped onion
• 125g	400g	Mushrooms, sliced
• 2 tbsp	3 tbsp	Cornflour
• 3 tbsp	5 tbsp	Dry white wine
• 400ml	750ml	Chicken stock
• 1tsp	2tsp	Mixed herbs
• 2	3	Egg yolks
• 75ml	150ml	Double cream
• pinch	pinch	Salt and pepper

Method:

- 1 Heat the butter in a Frying Pan and gently sauté the chicken in batches until sealed on all sides. Remove and set aside.
- 2 Add the onion and fry until softened but not browned. Add the mushrooms and cook for a minute on low heat.
- 3 Blend the cornflour with a little wine. Pour the remaining wine into the Pot with the blended cornflour, mixed herbs and seasoning. Bring to the boil, stirring continuously.
- 4 Transfer all ingredients to the Cooking Pot and cover with the Glass Lid.
- 5 Cook for approximately 6 hours on the Medium setting, or 8 hours on Low, 4 hours on High.
- 6 Just before serving, beat together the egg yolks and cream. Beat in a few tablespoons of the cooking liquid, mix well together. Pour this mixture into the Cooking Pot and stir until the sauce thickens.

Manual Recipes - Meat

New England Beef

Ingredients:

3.5L	6.5L	
• 1 tbsp	1 tbsp	Sunflower oil
• 1kg	1.5kg	Topside brisket of beef
• 1	1	Bouquet garni
• 1 tsp	2 tsp	Thyme
• 1 tsp	2 tsp	Black peppercorns
• 4	10	Shallots
• 225g	550g	Carrots, sliced
• 100g	300g	Swede, diced
•		Hot beef stock (or enough to cover the joint)
•		Pinch of salt

Method:

- 1 Heat the oil in a Frying Pan and sauté the beef on all sides.
- 2 Add the remaining ingredients, season with a little salt and then transfer the Cooking Pot into the Base Unit, cover with the Glass Lid.
- 3 Cook for approximately 4-6 hours on the High setting, 6-8 hours on Medium or 8-10 hours on Low.
- 4 Take the beef out of the Cooking Pot with a slotted spoon and allow to cool for 10 minutes. The cooking liquid can be used as a base to make gravy.
- 5 Cut the beef into slices and spoon a little of the cooking liquid over. Serve with vegetables and garnish with fresh parsley.

IMPORTANT: When buying a joint of meat, ensure it will fit into the Cooking Pot, so when it is covered with liquid it will be 2.5cm below the rim. The joint must not protrude above the rim and there should be enough room to cover the meat with stock. The shape of the meat is just as important as the weight.

Bolognese Sauce

Ingredients:

3.5L	6.5L	
• 700g	1.5kg	Minced beef
• 1	3	Large onion, chopped
• 3	6	Sticks of celery, thinly sliced
• 1	3	Garlic clove, crushed
• 3 tbsp	7 tbsp	Tomato puree
• 400g	3 x 400g	Canned chopped tomatoes
• 250ml	600ml	Beef stock
• 125g	300g	Mushrooms, sliced
• 1 tsp	2 tsp	Mixed herbs
• pinch	pinch	Salt and pepper to taste

Method:

- 1 In a Frying Pan, gently brown the mince on the hob without adding any fat or oil.
- 2 When the fat has started to run from the meat, add the onion, celery and garlic and sauté for a couple of minutes.
- 3 Add the remaining ingredients and mix well.
- 4 Transfer the Cooking Pot into the Base Unit, cover with the Glass Lid.
- 5 Cook for approximately 4-6 hours on the High setting, 6-8 hours on Medium or 8-10 hours on Low.

Beef Curry

Ingredients:

3.5L	6.5L	
• 3 tbsp	5 tbsp	Vegetable oil
• 2	3	Medium cooking apples, peeled, cored and sliced
• 2	3	Large onions, chopped
• 700g	1.5kg	Stewing steak, cubed
• 3 tsp	5 tsp	Curry powder
• 400ml	1L	Beef stock
• 3 tbsp	5 tbsp	Mango Chutney
• 75g	150g	Sultanas
• 200g	600g	Canned chopped tomatoes
• 2 tbsp	3 tbsp	Lemon juice
• 5 tbsp	5 tbsp	Cornflour
•		Salt and pepper, to taste

Method:

- 1 Add 1-2 tbsp oil, apple and onion to a Frying Pan and Sauté until softened. Remove and set aside.
- 2 Add a little more oil and sauté the meat in batches until browned.
- 3 Return the apple and onion to the Frying Pan.
- 4 Add the remaining ingredients and stir well.
- 5 Transfer the Cooking Pot into the Base Unit, cover the Glass Lid.
- 6 Cook for approximately 4-6 hours on the High setting, 6-8 on Medium or 8-10 on Low.
- 7 At the end of the cooking time, it may be necessary to thicken the sauce with a little extra cornflour made into a paste with a little cold water. Mix this with a cup of the hot liquid from the Cooking Pot and stir back into the Pot. This may be done 30 minutes from the end of cooking time.

Boiled Ham

Ingredients:

3.5L	6.5L	
• 1kg (max)	1.8kg (max)	gammon joint
•		Toasted breadcrumbs (to coat)

Method:

- 1 Remove the packaging from the joint but leave any collar in place.
 - 2 Drain and rinse the joint.
 - 3 Place the gammon joint into the Cooking Pot and fill the Cooking Pot with boiling water to cover the joint.
 - 4 Transfer the Cooking Pot to the Base Unit, cover with the Glass Lid.
 - 5 Cook for approximately 4-6 hours on the High setting, 6-8 hours on Medium or 8-10 hours on Low.
 - 6 Drain and cool slightly before removing the collar and skin.
 - 7 Allow to cool. Wrap tightly in kitchen foil.
 - 8 Place in the refrigerator until well chilled. Coat fat with toasted breadcrumbs before serving.
- IMPORTANT: When buying a joint of meat, ensure it will fit into the Cooking Pot. The joint must not protrude above the rim. The shape of the meat is just as important as the weight.

Sausage Pot

Ingredients:

3.5L	6.5L	
• 2 tbsp	1 tbsp	Oil
• 750g	1.5kg	Good quality sausages
• 1	3	Large onion, finely chopped
• 3	5	Carrots, thinly sliced
• 2	3	Leeks, sliced
• 3 tbsp	5 tbsp	Flour
• 400ml	1.5L	Beef stock
• 3 tbsp	6 tbsp	Chutney
• 2 tbsp	5 tbsp	Worcestershire sauce
• pinch		Salt and pepper

Method:

- 1 In a Frying Pan, sear the sausages in batch in the oil. Remove and set aside.
- 2 Add the onions, carrots and leeks and gently saute until softened, but not browned.
- 3 Stir in the flour and cook on a low heat until the oil is absorbed.
- 4 Slowly add the stock and bring to the boil, then stir in the chutney, Worcestershire sauce and seasoning.
- 7 Transfer the Cooking Pot into the Base Unit, cover with the Glass Lid.
- 8 Cook for approximately 4-6 hours on the High setting, 6-8 hours on Medium or 8-10 hours on Low.
Any excess fat can be removed from the surface of the finished dish with kitchen paper if necessary.

Manual Recipes - Desserts

Rice Pudding

Ingredients:

3.5L	6.5L	
• 25g	60g	Butter
• 100g	250g	Pudding rice
• 100g	250g	Sugar
• 1L	2L	Milk
• pinch	1tsp	Nutmeg

Method:

- 1 Butter the sides of the Cooking Pot
- 2 Add all the ingredients and stir well.
- 3 Transfer the Cooking Pot into the Base Unit, cover with the Glass Lid.
- 4 Cook for approximately 3-4 hours on the Medium setting.

Troubleshooting

Problem	Reason	Solution
<ul style="list-style-type: none"> Food is undercooked. 	<ul style="list-style-type: none"> Loss of power Food cooked on wrong setting for cooking time Glass Lid not placed correctly on the Cooking Pot 	<ul style="list-style-type: none"> Test the mains outlet with a lamp known to be working. Check the Control Knob position and the recipe details. Check the Glass Lid is correctly placed and nothing is obstructing it.
<ul style="list-style-type: none"> Food is overcooked. 	<ul style="list-style-type: none"> Cooking Pot was under half full Food cooked too long Cooking Pot placed in Base Unit while still very hot. 	<ul style="list-style-type: none"> The Slow Cooker has been designed to thoroughly cook food in a filled Cooking Pot. If the Cooking Pot is only half-filled, check to see if the food is cooked 1 to 2 hours earlier than recipe time. Check the Control Knob position and the recipe details. Cooking time may be shortened. Check food is cooked 30 minutes to 1 hour earlier than the stated recipe time.

Contact Us

Helpline

If you are having a problem with your appliance, please call our Helpline, as we are more likely to be able to help than the store you purchased the item from.

Please have the product name, model number and serial number to hand when you call to help us deal with your enquiry quicker.

UK Helpline: 0344 871 0944

IRE Helpline: 1800 409 119

Spares: 0344 873 0710

Talk To Us

If you have any questions, comments, want some great tips or recipe ideas to help you get the most out of your products, join us online:

Blog: www.morphyrichards.co.uk/blog

Facebook: www.facebook.com/morphyrichardsuk

Twitter: www.twitter.com/loveyourmorphy

Website: www.morphyrichards.com

SC460009 MUK Rev 2 06/19

Registering Your 2 Year Guarantee

Your standard one year guarantee is extended for an additional 12 months when you register the product within 28 days of purchase with Morphy Richards. If you do not register the product with Morphy Richards within 28 days, your product is guaranteed for 1 year. To validate your 2 year guarantee register with us online at www.morphyrichards.co.uk

Or call our customer registration line quoting model and serial number, these numbers can be found on the base of the product.

UK 0344 871 0242
IRE 1800 409 119

N.B. Each qualifying product needs to be registered with Morphy Richards individually.

Please note that the 2 year guarantee is only available in the UK and Ireland. Please refer to the one year guarantee for more information.

Your 1 Year Guarantee

It is important to retain the retailer's receipt as proof of purchase. Staple your receipt to this back cover for future reference.

Please quote the following information if the product develops a fault. These numbers can be found on the base of the product.

Model no.

Serial no.

All Morphy Richards products are individually tested before leaving the factory. In the unlikely event of any appliance proving to be faulty within 28 days of purchase, it should be returned to the place of purchase for it to be replaced.

If the fault develops after 28 days and within 12 months of original purchase, you should contact the Helpline number quoting Model number and Serial number on the product, or write to Morphy Richards at the address shown.

You may be asked to return a copy of proof of purchase.

Subject to the exclusions set out below (see Exclusions), the faulty appliance will then be repaired or replaced as appropriate and dispatched usually within 7 working days of receipt.

If, for any reason, this item is replaced or repaired during the 1 year guarantee period, the guarantee on the new item will be calculated from original purchase date. Therefore it is vital to retain your original till receipt or invoice to indicate the date of initial purchase.

To qualify for the 1 year guarantee, the appliance must have been used according to the instructions supplied. For example, crumb trays should have been emptied regularly.

Exclusions

Morphy Richards shall not be liable to replace or repair the goods under the terms of the guarantee where:

- 1 The fault has been caused or is attributable to accidental use, misuse, negligent use or used contrary to the manufacturer's recommendations or where the fault has been caused by power surges or damage caused in transit.
 - 2 The appliance has been used on a voltage supply other than that stamped on the products.
 - 3 Repairs have been attempted by persons other than our service staff (or authorised dealer).
 - 4 The appliance has been used for hire purposes or non domestic use.
 - 5 The appliance is second hand.
 - 6 Morphy Richards reserves the right not to carry out any type of servicing under the guarantee at its discretion
 - 7 Plastic filters for all Morphy Richards kettles and coffee makers are not covered by the guarantee.
 - 8 Batteries and damage from leakage are not covered by the guarantee.
- This guarantee does not confer any rights other than those expressly set out above and does not cover any claims for consequential loss or damage. This guarantee is offered as an additional benefit and does not affect your statutory rights as a consumer. Morphy Richards products are intended for household use only. See usage limitations within the location safety instructions.

Disclaimer

Morphy Richards has a policy of continuous improvement in product quality and design. The company, therefore reserves the right to change the specification of its models at any time.



For electrical products sold within the European Community. At the end of the electrical products useful life, it should not be disposed of with household waste.

Please recycle where facilities exist. Check with your Local Authority or retailer for recycling advice in your country

**IF YOU ARE HAVING A PROBLEM
WITH ONE OF OUR PRODUCTS,
CALL OUR HELPLINE:**

UK: 0344 871 0944
EIRE: 1800 409 119
SPARES: 0344 873 0710

morphyrichards

The After Sales Division
Morphy Richards Ltd
Mexborough, South Yorkshire,
England, S64 8AJ

Helplines (office hours)
UK 0344 871 0944
Spare Parts 0344 873 0710
Republic of Ireland 1800 409 119
www.morphyrichards.com

